



**Atacama  
Large  
Millimeter /  
submillimeter  
Array**

## **Interface Control Document Between ALMA Phasing Project And ALMA Site**

**ALMA-05.11.10.00-20.00.00.00-A-ICD**

2014-10-14

<b>Prepared By:</b>	<b>Organization Role:</b>	<b>Date and Signature:</b>
R. Lacasse / Bill Shillue	NRAO	
Geoff Crew	Haystack Observatory	
<b>Approved By:</b>	<b>Organization Role:</b>	<b>Date and Signature:</b>
Richard Lacasse	APP SE/Lead Engineer	
Nick Whyborn	ALMA Array Lead Engineer	
Serge Guniat	IET Site	
<b>Released By:</b>	<b>Organization Role:</b>	<b>Date and Signature:</b>
Michael Hecht	APP Project Manager	



## Change Record

Version	Date	Affected Section(s)	Author	Reason/Initiation/Remarks
A	2013-3-5	ALL	None	First Issue
A.1	2013-3-14	Several	None	Incorporate comments from Saez
A.2	2013-3-19	Several	None	Assign document number Incorporate comments from Saez
A.3	2013-4-22	Fig. 3.6	None	Change figure 3.5 due to decision on how to drive CRGs from Maser
A.4	2013-5-11	3.3.1.1, 3.3.1.2, Section #'s 3.2		Update power dissipation of Fiber Mux and Demux. Fix incorrect section numbers. Fix typos
A.5	2013-6-19	3.3, 3.4		Add weight of Fiber Mux/Demux Add weight of Recorder Changed document number to new format
A.6	2014-09-10		Alex Caceres	Regular ICD number has been assigned.
A.7	2014-09-29		F. Sepulveda	Signature matrix modified
A.8	2014-10-07	Several	Rich Lacasse	Update Table 2 Update Figure 5 Updated description of 1-PPS Distributor Eliminate section on the Maser TTL to LVDS converter which is not needed.
A.8	2014-10-14	3.1.5.1.4	Rich Lacasse	Specify connector for PDU



## Table of Contents

1	Description .....	5
1.1	Purpose.....	5
1.2	Scope.....	5
2	Applicable Document, Reference Documents, Acronyms and Definitions .....	6
2.1	Applicable Documents.....	6
2.2	Reference Documents .....	6
2.3	Abbreviations and Acronyms .....	7
3	Interfaces to Various Subsystems .....	7
3.1	Hydrogen Maser.....	7
3.1.1	Introduction.....	7
3.1.2	Seismic Requirements.....	7
3.1.3	Mechanical Interface.....	7
3.1.4	Thermal Interface.....	12
3.1.5	Electrical Interface .....	13
3.1.6	Equipment Installation .....	17
3.2	64-Antenna Correlator Upgrades .....	17
3.2.1	Interfaces to Site .....	17
3.3	Optical Fiber Link System Interface.....	19
3.3.1	Interface to Site .....	20
3.4	VLBI Recorder Interface .....	24
3.4.1	Subsystem Description.....	24
3.4.2	Interface to Site .....	25



## List of Figures

Figure 3-1: ALMA AOS LO Room Layout with H-Maser Rack (HMR) shown in blue.....	9
Figure 3-2: Photo of CLOA Racks with intended position of H-Maser indicated, as well as the location of the unused rack slots.....	9
Figure 3-3: LO room floor before racks installation showing: outline of isolated pad, seismic support structure, bolt patten, and AC power receptacles .....	11
Figure 3-4: Four temperature sensors in the Central LO racks, plotted for two days.....	13
Figure 3-5: Receptacles provided for the H-maser .....	14
Figure 3-6: Layout of CLOA racks and positions of the AC power and UPS power outlets .....	15
Figure 3-7: UPS power cord termination.....	16
Figure 3-8: AC power cord termination.....	16
Figure 3-9: Photo of H-Maser UPS battery assembly .....	17
Figure 3-10: Photo of the Fiber Multiplexer and Fiber Demultiplexer during test .....	20
Figure 3-11: Illustrations of a Shuko type connector.....	21
Figure 3-12: Photo of the Patch Panel module in the Computing room to which the Fiber Multiplexer interfaces .....	21
Figure 3-13: Plan view of the OSF archive room showing the location of the APP equipment .....	23
Figure 3-14: APP equipment mounting in OSF archive room racks .....	24
Figure 3-15: Photo of one of four recorders required for the APP .....	25

## List of Tables

Table 1: Temperature variation versus time scale .....	12
Table 2: Summary of cable tray usage by correlator-upgrade-related cables.....	19
Table 3: Weight of one recorder, loaded with the maximum of 4 disk modules.....	25



# 1 Description

## 1.1 Purpose

This ICD covers the all interfaces between the ALMA Site and the ALMA Phasing Project. The Phasing Project has subsystems located at both the OSF and AOS.

## 1.2 Scope

The ALMA Phasing Project provides ALMA with the capability of phasing up to 63 Antennas and recording the resulting data for later correlation at another facility (e.g., Haystack Observatory). Equipment associated with the project includes a hydrogen maser for VLBI phase stability, various upgrades to the 64-Antenna Correlator, an optical data transmission system to transmit data over a single fiber from the AOS to OSF and a data recording system. A GPS receiver in the correlator room with antenna installed on the roof of the AOS technical building is also included as an independent time reference for checking time. This equipment is more fully described in [AD01]. Some of these subsystems may have several interfaces to the ALMA Observatory (e.g. hardware and software). These are covered in four separate ICDs: with Back End, Computing, Correlator and Site. Aspects of the interface concerning physical location of devices, power, cooling requirements, mechanical interfaces and similar things are included in this, the ICD with ALMA Site.

The ALMA Phasing Project is described in the following document [AD01].

The ALMA Central LO Article design is defined in [AD02] and its performance requirements are detailed in [AD03]. A summary of interface requirements between the ALMA CLOA and the ALMA AOS Technical Building in which it resides is included in [AD04].

The ALMA Environmental requirements, which includes environmental requirements and conditions presented in the AOS Technical Building and at the OSF site, is contained in [AD05]. Seismic specifications are detailed in [AD06].



## 2 Applicable Document, Reference Documents, Acronyms and Definitions

Applicable documents are necessary for the understanding of this document. In some cases, they provide additional requirements which are to be incorporated into the ICD. Reference documents are supplemental and simply provide further reference for various topics. In most cases, the acronyms used in this document are consistent with ALMA defined acronyms, however additional acronyms have also been listed which are outside the scope of ALMA definitions. No distinction is made between these two uses.

### 2.1 Applicable Documents

The following documents, of the exact issue shown, form part of this document. In the event of conflict between the documents listed here and this document, this document shall take precedence.

Ref.	Document Title	Reference
[AD01]	APP Project Plan <i>Release</i>	ALMA Phasing Project, Project Plan, latest version
[AD02]	BE IPT CLOA Design Description	<a href="#">BEND-50.01.00.00-012-A-DSN</a>
[AD03]	Central LO Article Verification and Acceptance Plan	<a href="#">BEND-50.01.00.00-002-A-PLA</a>
[AD04]	ICD between AOS Technical Bldg and BE Central Equipment	<a href="#">ALMA-20.01.02.00-50.00.00.00-A-ICD</a>
[AD05]	ALMA Environmental Specification	<a href="#">ALMA-80.05.02.00-001-B-SPE</a>
[AD06]	Seismic Design Specifications for ALMA-AOS and ALMA-OSF	<a href="#">SYSE-80.10.00.00-002-B-REP</a>
[AD07]	General Safety Design Specification	<a href="#">ALMA-10.08.00.00-003-B-SPE</a>
[AD08]	Product Assurance Requirements	<a href="#">ALMA-80.11.00.00-001-B-GEN</a>

### 2.2 Reference Documents

Ref.	Document Title	Reference
[RD01]	AOS Technical Building Completion Package Construction Specifications	<a href="#">SITE-20.01.02.03-027-A-SPE</a>
[RD02]	ALMA Project Backend IPT Seismic Support Specification	<a href="#">BEND-57.00.00.00-001-A-SPE</a>
[RD03]	ALMA Project Backend IPT Addendum to Seismic Support Specification	<a href="#">BEND-57.00.00.00-003-A-SPE</a>
[RD04]	ALMA Back End IPT Central LO Seismic Rack SPECIFICATION	<a href="#">BEND-57.02.03.00-002-A-SPE</a>
[RD05]	Central LO Rack Production Drawings	<a href="#">BEND-57.02.03.00-006-A-DWG</a>
[RD06]	Operation and Maintenance Manual for CLOA Equip. Racks	<a href="#">BEND-57.02.03.00-005-A-MAN</a>
[RD07]	iMaser™ 3000, Installation, Operation & Maintenance User Manual, Issue 1.7, 28-May-2010	T4S-MAN-0012, available from <a href="http://www.T4Science.com">www.T4Science.com</a>
[RD08]	iMaser™ 3000 Specifications	<a href="http://www.t4science.com/documents/iMaser_Clock_Spec.pdf">http://www.t4science.com/documents/iMaser_Clock_Spec.pdf</a>
[RD09]	Test Report for T4S iMaser s/n 59	T4 Science SA, Doc. No. Test Report 0029
[RD10]	64 Antenna Correlator Specifications and Requirements	<a href="#">ALMA-60.00.00.00-001-C-SPE</a>
[RD11]	Interface Control Document Between 64-Antenna Correlator And Correlator Computing System	<a href="#">ALMA-60.00.00.00-70.40.00.00-E-ICD</a>
[RD12]	Interface Control Document Between APP and Back End	ALMA-05.11.10.49-50.00.00.49-A-ICD
[RD13]	Interface Control Document Between APP and Computing	ALMA-05.11.10.49-70.00.00.49-A-ICD
[RD14]	Interface Control Document Between APP and Correlator	ALMA-05.11.10.49-60.00.00.49-A-ICD



## 2.3 Abbreviations and Acronyms

All acronyms and abbreviations used within this document are given at the [ALMA Acronym Finder](#) web page.

## 3 Interfaces to Various Subsystems

This section includes the detailed interfaces to the various subsystems comprising the ALMA Phasing System. A section is dedicated to each subsystem.

### 3.1 Hydrogen Maser

#### 3.1.1 Introduction

VLBI observations require extremely good phase stability because phase stability between geographically separated telescopes is required (Allan deviation of  $2 \times 10^{-15}$  at 1000 seconds). This is a contrast with connected interferometers, like ALMA, where frequency references for all antennas are derived from a single reference. The frequency reference provided with the original ALMA array, while adequate for connected-element interferometry, is not adequate for VLBI at millimeter wavelengths. Thus a hydrogen maser is provided as a deliverable of the Phasing Project.

In particular, the hydrogen maser provided is:

**Manufacturer:** T4 Science SA

**Model Number:** iMaser 3000

This sub-system has interfaces to the site infrastructure, detailed below, to the Central LO system and to computing as detailed [RD12] and [RD13] respectively.

For time-tagging VLBI data, the Correlator requires a 1-Pulse-per-Second (1 PPS) signal synchronized to the maser. The site aspects of this sub-system are also covered below.

#### 3.1.2 Seismic Requirements

The ALMA site is a seismically active site. The seismic environment at the Array Operations Site (AOS) is defined in [AD05], and further elaborated in [AD06].

These documents specify the seismic environment, and in response a seismic design was implemented for the AOS Technical Building [RD01], AOS LO room seismic support structure [RD02], [RD03], and Central LO Article racks with Zone IV rating [RD04], [RD05], and [RD06]. The modification to the ALMA CLOA required to implement the ALMA Phasing Project shall comply with [AD05] and [AD06], by installing the H-maser in a Zone-IV rated rack with attachment to the existing seismic support structure.

#### 3.1.3 Mechanical Interface

In this section, detailed definition and requirements are given for any new elements that require new hardware or physical modification.



### 3.1.3.1 H-Maser

The H-Maser chosen for the ALMA Phasing Project is the iMaser 3000 from T4 Science [RD07] and [RD08]. The H-Maser consists of commercial electronics and a physics package mounted in a sheet metal RFI rack. *For purposes of this document, this entire assembly is called the H-maser.*

### 3.1.3.2 H-Maser rack

To satisfy the seismic requirement and provide auxiliary electronics and environmental control, the H-Maser shall be mounted in a custom seismic rack. *This rack is hereafter called the Hydrogen Maser rack (HMR).*

### 3.1.3.3 HMR Location

The CLOA racks are designed to sit in two rows of 7 racks. In the final configuration, not all rack slots were used. From the beginning of the CLOA design, a rack slot was allotted for a hydrogen maser. This is shown in the following figure, which is a scaled layout of the ALMA Array Operations Site Technical Building LO Room [AD02]. The rack space allocated for the H-Maser is shown in blue. *The HMR can be located in any of the three positions colored blue or gray.* The original CLOA design left a space for the HMR which is denoted by the blue colored slot shown in the figure below. The gray slots are unused slots. The blue slot has the advantage of being more isolated (further from the door and foot traffic) and having a shorter cable run to the CRG which is in the CVRR1 rack. However, if the HMR does not fit in the blue slot then the other two unused slots are available. Note: It has been anticipated that due to the fact that the H-maser width is very nearly equal to one rack slot width, the HMR may need to be an oversized custom rack that occupies all or part of both gray slots.

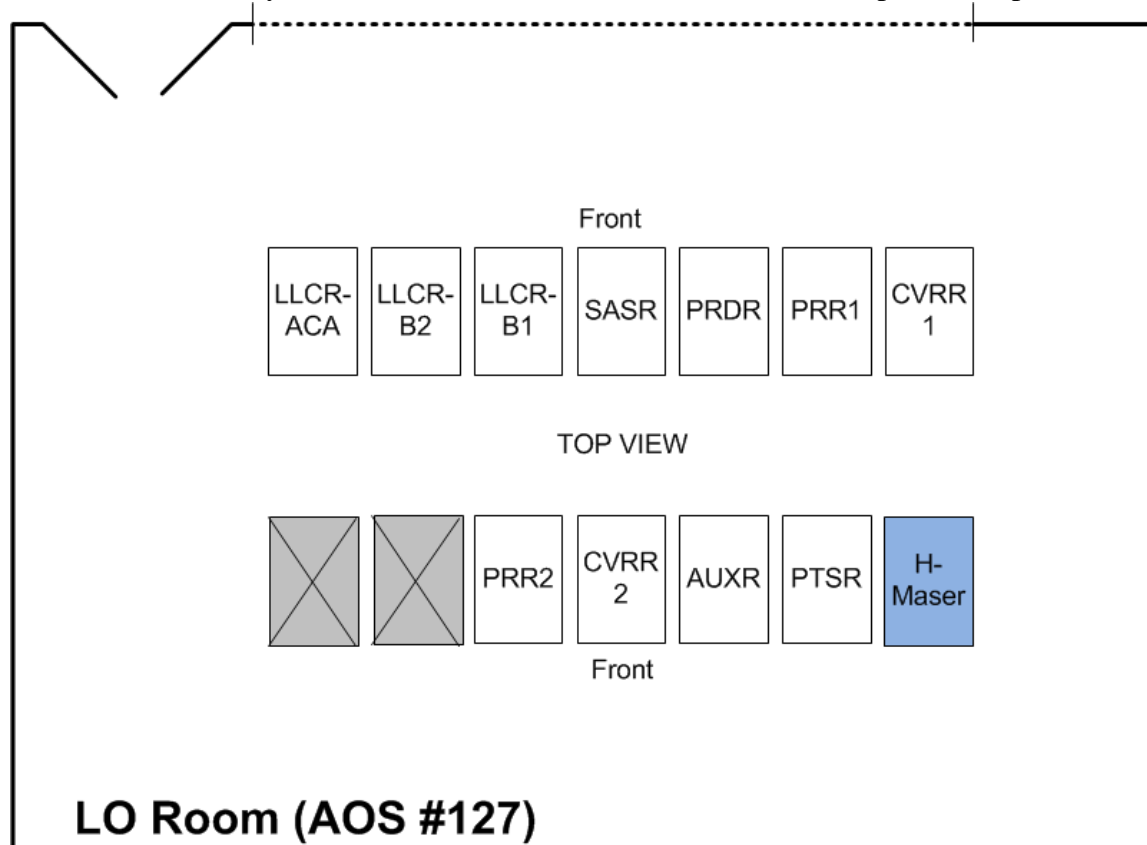





Figure 3-1: ALMA AOS LO Room Layout with H-Maser Rack (HMR) shown in blue

In Figure 3-1, this blue slot was intended for HMR, but the unused slots (labeled X) are also available.

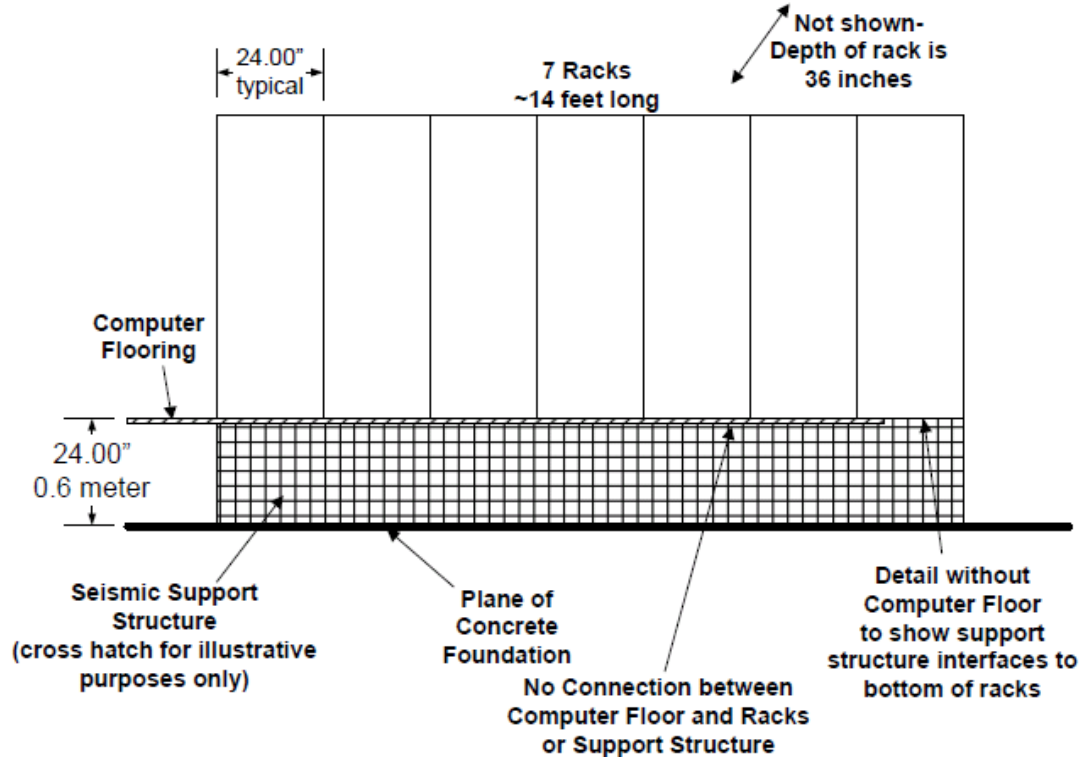

Figure 3-2: Photo of CLOA Racks with intended position of H-Maser indicated, as well as the location of the unused rack slots

Note: the tape on the floor covers the small gap between the raised floor of the room and the raised floor over the isolated LO room concrete pad.

### 3.1.3.4 CLOA Rack Seismic Support Structure

The mechanical interface is to the LO room seismic support structure. The requirements for this support structure are detailed in [RD02] and [RD03].



A seismic support structure meeting the ALMA requirements is already installed in the AOS LO room, supporting the CLOA racks that are in place. This structure meets all requirements listed in [RD02] and [RD03], for example stress analysis, seismic rating, material, fastening, height, levelness, ...etc.

The seismic structure has four bolt holes for each rack location. Each bolt hole is 0.750 inch diameter thru hole. The existing racks and seismic structure both have thru holes, and the racks are attached to the seismic structure by means of an M16 x 2 x 70mm bolt with a torque nut on the underside of the seismic structure.

The steel support structure is 0.6 meter high and the top of the structure shall be even with the top of the raised computer flooring. The computer floor is cut away in the area where the racks and support structure are located, as shown in Figure 3-3.



Figure 3-3: LO room floor before racks installation showing: outline of isolated pad, seismic support structure, bolt patten, and AC power receptacles

### 3.1.3.5 CLOA Racks

The Central LO rack specifications have been set forth in [RD04]. The Central LO Rack mechanical production drawings of the racks procured to meet these specifications are detailed in [RD05]. These racks are 611.2 mm, 916.0 mm, 1692.3 mm in width, depth, and height. The racks are intended to bolt to each other in the width direction with up to seven racks per row. More design details of the racks are given in [RD06]. As shown in Figure 3-1 and Figure 3-2, only four of the seven racks in the 2<sup>nd</sup> row have been installed at the time that this document has been prepared. There is one slot at one end, and two slots at the other end which are available for the H-maser installation.

### 3.1.3.6 Modified Rack for HMR

Note that if it is not possible for an existing spare CLOA rack to be used as the HMR, then the HMR will need to be another suitable Zone-IV rated seismic rack (see section 3.1.3.5) in one of the available slots, and attached to the existing seismic support structure (see section 3.1.3.4).

As supplied by the vendor, the H-maser does not meet ALMA seismic specifications, and thus will need to be repackaged to meet those specifications. The most straightforward approach is to use a Zone-IV rack as similar as possible to the existing CLOA racks, but possibly with increased width. The compliance with ALMA seismic requirement verification shall then be made by an appropriate analytical perturbation from the original design.

### 3.1.3.7 Cable trays

Inter-rack cabling associated with the maser installation will use existing cable trays. Required cables are shown in Thermal Interface



### 3.1.4 Thermal Interface

In this section, detailed description of the existing AOS and LO room air handling and temperature stability is given. This defines the environment within which the H-Maser will need to operate.

There is forced air flow available for the H-maser if it is needed. Currently, there are eleven racks deployed in the LO room. The addition of one more rack may be expected to result in a decrease of about 10% in air flow to the existing racks. The CLOA is very sensitive to temperature, and the equipment and temperature environment is already optimized. Therefore there is some risk associated with the H-maser installation if air flow is required.

1. If forced air cooling is required for the H-maser, a joint plan must be developed between the APP project and the ALMA Backend and Maintenance teams and approved by the ALMA project in Chile.
2. If forced air flow cooling is not required for the H-maser, then the H-maser and its mechanical adapter shall be installed in such a way that the air seal is preserved at the joint between the seismic structure and the raised floor.

#### 3.1.4.1 Air Flow

Air Flow of 200-400 cubic feet per minute can be expected depending on the cross sectional area of the vertical duct through the HMR. (Alternatively, the duct can be totally blocked if the H-Maser requires no air flow).

#### 3.1.4.2 Temperature Stability

Inlet temperature is approximately 15 deg C. Temperatures measured in existing CLOA racks have stability versus timescale as follows:

Timescale	Temperature change deg C	
	Typical	Maximum
24h	0.6 deg	0.6 deg
6h	0.3 deg	0.5 deg
1h	0.1 deg	0.2 deg
20 minutes	0.1 deg	0.1 deg

**Table 1: Temperature variation versus time scale**

The plot below shows four temperature sensors located in the CLOA racks over a two day period.

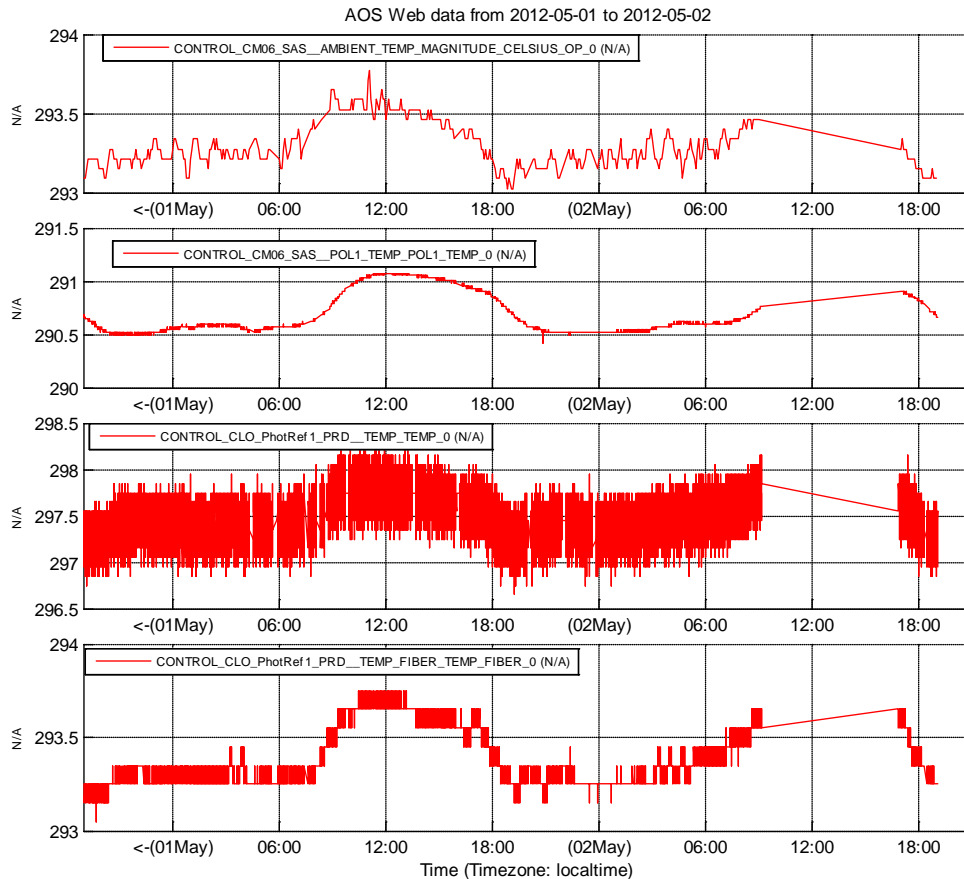

Figure 3-4: Four temperature sensors in the Central LO racks, plotted for two days

In the plot above the top curve is a temperature sensor in the forced air space, and the 2<sup>nd</sup> curve from the top represents a temperature sensor in a region where there is no air flow. The forced air provides a benefit in removing heat. However, if the heat does not need to be removed by forced air, then the resulting temperature stability may be improved in short (i.e < 30 minute) timescales.

### 3.1.5 Electrical Interface

The figure below serves to illustrate the interface descriptions described in this section and the following section, that is, the electrical and electronic interfaces between the ALMA Phasing Project Hydrogen Maser Rack and the ALMA Central LO Article.

#### 3.1.5.1 Electrical Power

All equipment shall operate from 230 VAC, 50 Hz single phase power. Power outlets are provided under the floor near the base of each rack. The H-maser meets this requirement as it operates from 176-264 VAC at 48 to 400 Hz.



It is required that the HMR be equipped with flexible AC power cords, one for UPS power and one for non-UPS power. Two AC receptacles are provided under each rack, as shown in Figure 3-5 and Figure 3-6.



**Figure 3-5: Receptacles provided for the H-maser**

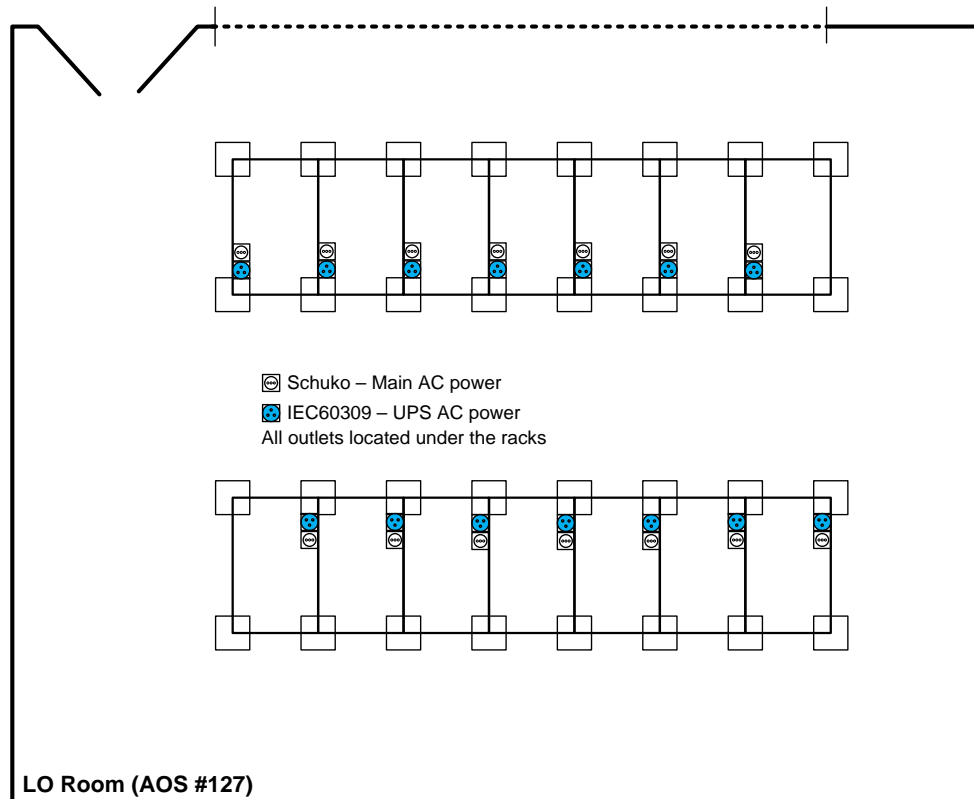

Figure 3-6: Layout of CLOA racks and positions of the AC power and UPS power outlets

The receptacles for mains power and AC power are differentiated as follows:

An IEC60309 receptacle provides UPS power.

A Schuko receptacle provides non-UPS power.

### 3.1.5.1.1 Electrical Power Dissipation

The LO Room power allocates 1kVA per rack [AD04]. The H-Maser dissipates less than 0.2kVA when fully powered.

### 3.1.5.1.2 UPS power cord specification

A 1-meter power cord terminated with an IEC60309 connector. The other end is terminated with an IEC 60320 inlet type C14 plug.

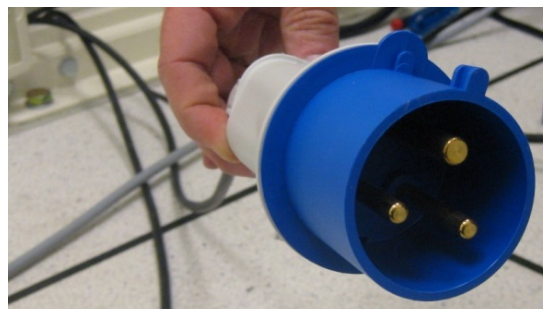
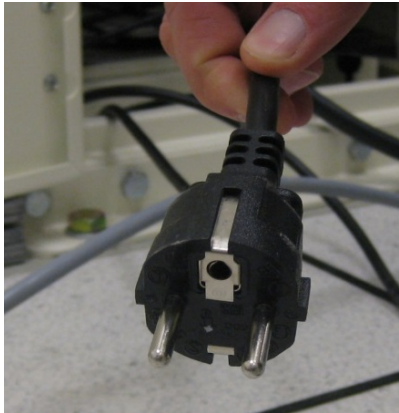



**Figure 3-7: UPS power cord termination**

### **3.1.5.1.3 Non-UPS power cord specification**

A 1-meter power cord terminated with a Schuko connector. The other end is terminated with an IEC 60320 inlet type C14 plug.



**Figure 3-8: AC power cord termination**

### **3.1.5.1.4 Power Distribution Unit**

The HMR shall be equipped with a power distribution unit (PDU) as detailed in [AD02], sec 11.4. The PDU provides AC filtering, surge suppression, and allows remote powerup/down, and emergency shutdown.

Output connector: IEC 60320

### **3.1.5.1.5 H-Maser UPS batteries**

The H-Maser has a UPS battery assembly consisting of two batteries and a charging assembly. The batteries' charger assembly has a 230V, 50 Hz AC input with an IEC320 inlet receptacle connector. AN AC power cord is required between the Power Distribution Unit and the battery charger assembly. The batteries are connected to the H-maser by a custom DC cable provided by the H-maser manufacturer. This assembly shall be hard mounted within the HMR.





Figure 3-9: Photo of H-Maser UPS battery assembly

### 3.1.6 Equipment Installation

The HMR rack installation is a disruptive event for the ALMA CLOA. The CLOA and its associated HVAC unit must be shut down for safety reasons during this installation.

## 3.2 64-Antenna Correlator Upgrades

The specification for the 64-Antenna Correlator [RD10] includes a requirement that the correlator provide “hooks” for VLBI. To take advantage of these hooks, various modifications to the correlator are required. Hardware modifications to the correlator are documented separately in [RD14]. This section details the interface between ALMA Phasing Equipment housed in the 64-Antenna Correlator room and ALMA site.

### 3.2.1 Interfaces to Site

#### 3.2.1.1 1-PPS distributor

A 1-PPS distributor is required to distribute two different 1-PPS signals to each PIC. (The PICs are new boards which will be installed in the correlator and are described below.) The 1-PPS signals originate from the 1-PPS distributor in the CLO room and from a local GPS receiver (described below) located in the correlator room. In addition, the 1-PPS distributor shall receive 1-PPS signals from the 8 PICs and make them available on connectors for monitoring. The 1-PPS Distributor is simply and Final Adder Board with different firmware and FPGA personalities. A TTL to LVDS converter board will be mounted in the correlator rack behind the distributor. APP will provide the converter, associated cables and mounting hardware.

**Physical location:** In quadrant 2, bin 1

**Rack space requirements:** None. Mounts in the correlator

**Power requirement:** Uses available correlator rack power and clock.



**Cooling:** None. Uses existing rack cooling

### 3.2.1.2 GPS receiver sub-system

A GPS receiver will be located in the correlator room. Its antenna and the cable between the antenna and receiver shall be installed by ALMA personnel. This system mainly serves as a redundant check of the 1-PPS primary time reference derived from the maser.

**Physical locations:** The receiver (we shall likely select the Symmetricom XL-AK receiver for compatibility with an existing receiver at the ALMA site.) shall be mounted in the communications rack in the correlator room. The antenna shall be mounted on the AOS building's roof in a location to be agreed upon by Alejandro Saez and a site representative. A cable will connect the antenna to the receiver. ALMA personnel shall install the antenna and cable. ***ALMA will supply rack-mounting hardware, such as captive nuts and screws, compatible with the rack.***

**Rack space requirements:** 3U, 19" rack mounted (receiver).

**Power requirement:** 95 – 260 VAC, 47 – 440 Hz, < 15 W. A Shuko-type receptacle in the communications rack is the interface point.

### 3.2.1.3 Start-Stop Counter

**Optionally**, a time interval counter will be supplied, similar to Agilent 53220A. Its purpose is to monitor the time difference between two selected 1-PPS signals during installation and commissioning. It will not be used in routine operations. (I.e. there will be no software support for it.) This is a subset of the capability provided by the PICs but provides instant, fool-proof indications which may be useful during commissioning.

**Physical location:** Communications rack in the correlator room. ***ALMA will supply rack-mounting hardware, such as captive nuts and screws, compatible with the rack.***

**Rack space requirements:** 4U, 19" rack mounted.

**Power requirement:** < 150W. A Shuko-type receptacle in the communications rack is the interface point.

**Communications:** A connection to the site network is required to allow monitoring, but not monitoring software or logging is required.



### 3.2.1.4 Cabling

Existing cable trays at the AOS will be used to route cables. Table 2 below, provides details.

Signal	Cable Type	From	To	Qty
Maser 1-PPS	RG-223	CLO Room	Corr. Room 1-PPS TTL to LVDS Conv.	1
Maser 1-PPS copies	LVDS	Corr Room 1-PPS Dist.	All PICs	8
GPS 1-PPS copies	LVDS	Corr Room Comm. Rack	All PICs	8
PIC 1-PPS	LVDS	All PICs	Corr Room 1-PPS Dist.	8
PIC Sum Data	Optical CX4	All PICs	Fiber Mux/Demux	8
PIC Comm. Ethernet	CAT-5	All PICs	Eng Port Computer	8

Table 2: Summary of cable tray usage by correlator-upgrade-related cables

## 3.3 Optical Fiber Link System Interface

The purpose of this sub-system is to transmit the antenna sum data from the AOS to the OSF while using minimal fiber resources. The eight 10 GbE data streams are wavelength-division-multiplexed onto one fiber at the AOS. This data is transmitted to the OSF where it is demultiplexed and routed to the appropriate recorder sub-system. The optical fiber link system (a pair of a transmitter and a receiver) is fully symmetric and the two devices are inter-changeable as they are totally in the same design. The device has no packet monitoring capability, so it is a passive participant in the VLBI phasing system.

**Manufacturer:** Elex Engineering

**Model Number:** XW-100 (both the transmitter and the receiver)

The part of this subsystem that is installed at the AOS is called the Fiber Multiplexer. The part that is installed at the OSF is called the Fiber Demultiplexer. The Multiplexer and Demultiplexer are identical devices. Both can transmit and receive data. In the APP application, the Multiplexer will transmit to the Demultiplexer, but no transmission is planned in the other direction. A photograph of the two devices, placed side-by-side for test purposes is shown in Figure 3-10 below.



Figure 3-10: Photo of the Fiber Multiplexer and Fiber Demultiplexer during test

The interface to site for both devices is detailed below.

### 3.3.1 Interface to Site

#### 3.3.1.1 Fiber Multiplexer

The mechanical, electrical, correlator and computing interfaces are presented below.

#### Physical location:

AOS, Correlator Room, Communications Rack

#### Rack space requirements:

8U , 19" rack mounted. (The equipment is only 5U, but additional space is required for cooling at the AOS.) *ALMA will supply rack-mounting hardware, such as captive nuts and screws, compatible with the rack.*

#### Power requirement:

120 or 230 V, 50/60 Hz, less than 150 W. The interface point is an AC connector on the power strip in the communications rack. Connector type on the power strip is a Shuko type. See



<http://en.wikipedia.org/wiki/Schuko>

and Figure 3-11 below.



Figure 3-11: Illustrations of a Shuko type connector

### Cable tray space:

- Eight optical fibers are required from the PICs in the correlator to the fiber mux in the Communications Rack in the Correlator Room. These fibers will be supplied by the Phasing Project.
- One optical fiber is required from the AOS Correlator Communications Rack to the AOS Computing Room Fiber Rack. The fiber (approximately 30 meters in length) will be supplied by the Phasing Project. The interface point is the type SC connector in the Computing Room Fiber Rack which completes the connection to the Fiber Demux at the OSF. See Figure 3-12 below.

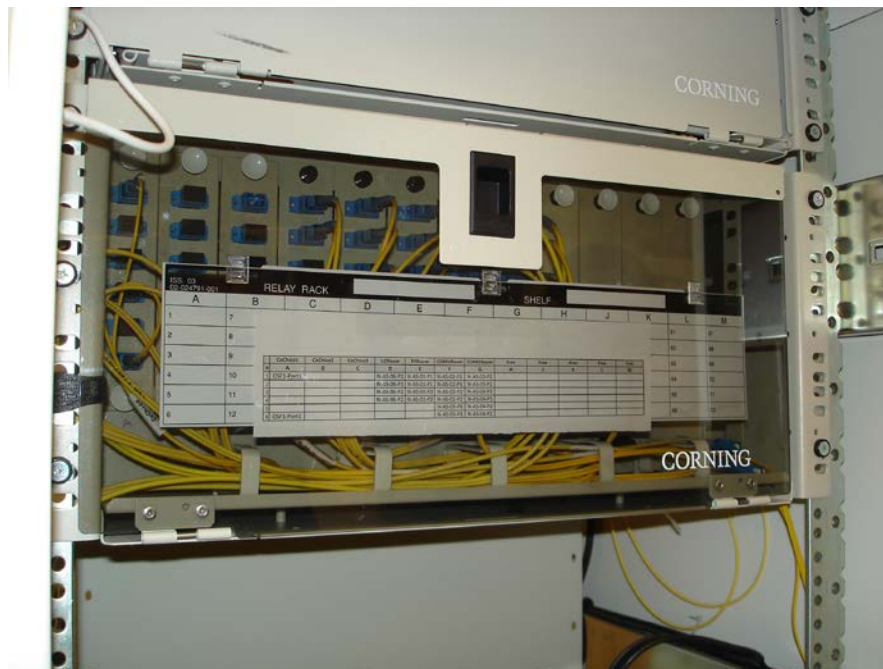

Figure 3-12: Photo of the Patch Panel module in the Computing room to which the Fiber Multiplexer interfaces



**Optical connector:** The interface point is the optical connector in the patch panel. The connector type is “SC”.

**Connection to Ethernet required:** 10BASE-T / 100BASE-TX: no CAN bus connection.

**Cooling:** Air intake from front of chassis; air exhaust from rear of chassis.

**Weight:** 15 kg.

### 3.3.1.2 Fiber Demultiplexer

**Physical location:**

OSF, Archive Room, in Rack 11. See **Error! Reference source not found.** for rack location  
See **Error! Reference source not found.** for the location of Demultiplexer within the rack.

**Rack space requirements:**

5U , 19” rack mounted. *ALMA will supply rack-mounting hardware, such as captive nuts and screws, compatible with the rack.*

**Power requirement:**

120 or 230 V, 50/60 Hz, less than 150 W. The interface point is a connector located in the power strip in the rack where the Fiber Demultiplexer will be mounted. The connector type is IEC320C13.

**Cable tray space:**

- One optical fiber from the rack in which the fibers from the AOS terminate, Rack 11, to the Patch Panel Module in Rack 1. This fiber will be supplied by the Phasing Project.
- Eight optical fibers from the fiber demux to the recorders, located in Racks 11 and 12 (see Figure 3-13 and Figure 3-14). These fibers will be supplied by the Phasing Project.

**Optical connector:** The interface point is the optical connector in the patch panel. The connector type is “SC”.

**Connection to Ethernet required:** 10BASE-T / 100BASE-TX: no CAN bus connection.

**Cooling:** Air intake from front of chassis; air exhaust from rear of chassis.

**Weight:** 15 kg.

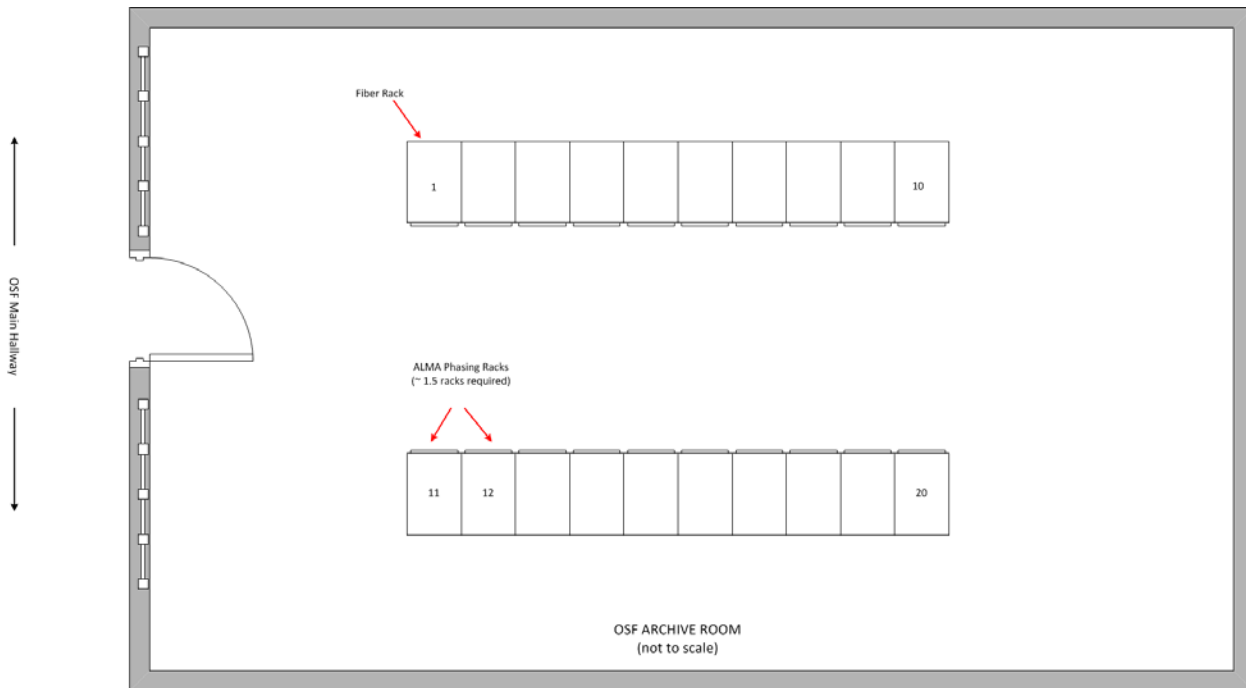

**Figure 3-13: Plan view of the OSF archive room showing the location of the APP equipment**

In Figure 3-13, racks are numbered 1 to 20 as shown. APP equipment is located in racks 11 and 12. Plan is not to scale.

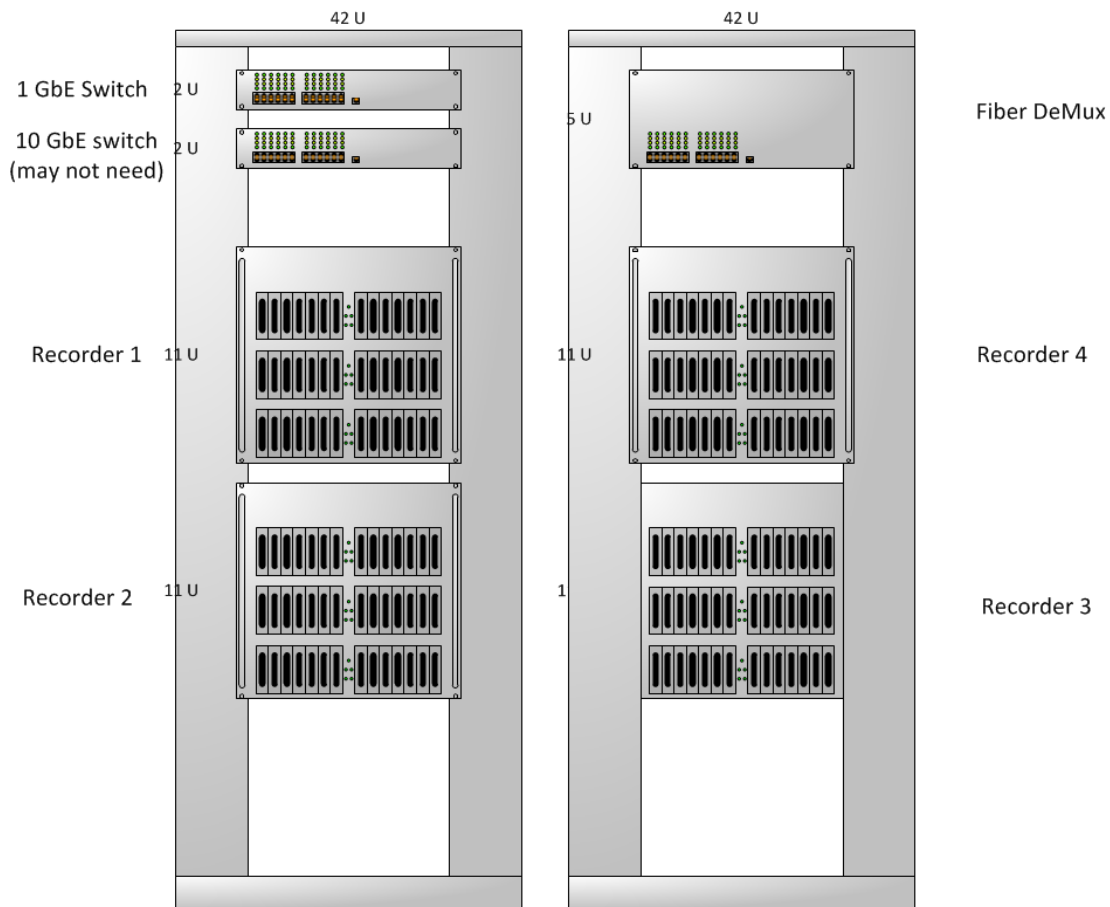

Figure 3-14: APP equipment mounting in OSF archive room racks

### 3.4 VLBI Recorder Interface

The function of the recorder subsystem is to record, on computer disks, the antenna sum data that is computed by the correlator and transmitted via the optical fiber link system. The disks are then shipped to a correlator facility, such as Haystack Observatory, to be correlated with data from other VLBI sites.

#### 3.4.1 Subsystem Description

The recorder selected for the APP is the Mark 6 VLBI Data System. This system is a disk-based recording system to support capturing digital data from VLBI observations at up to 16Gbps sustained data rate to an array of 32 disks. **Each of the four** recorders that will comprise the APP record system has the following properties:

**Data interface:** Four 10GigE connections from data source

**Maximum input data rate:** 16Gbps; maximum ~4Gbps per 10GigE port

**Data recording media:** 32 disks configured in four removable 8-disk modules (3.5" SATA)

**M&C interface:** Gigabit Ethernet

**M&C protocol:** VSI-S; alternate XML interface planned





**Physical size:** Two 5U 19"-wide rack-mount equipment (30" deep) chassis plus one 1U 19"-wide rack-mount cable organizer panel (see Figure 1).



**Figure 3-15: Photo of one of four recorders required for the APP**

**Data capacity:** When populated with 32 2TB standard SATA disks, an aggregate 16Gbps input data stream can be recorded continuously for ~8 hours before disk modules are filled.

**Weight:**

Component	Weight(kg)
System Chassis	23
Expansion Chassis	18
Disk modules (qty 4)	33
Cable panel and panels	1
<b>Total (w 4 disk modules)</b>	<b>75</b>

**Table 3: Weight of one recorder, loaded with the maximum of 4 disk modules**

**3.4.2 Interface to Site**

**Physical location:** OSF, Archive Room. Location of the racks in which the recorders are housed are shown in Figure 3-13. Locations of the recorders within the racks are shown in Figure 3-14. The interface point is a connector located in the power strip in the rack where the Fiber Demultiplexer will be mounted. The connector type is IEC320C13. *ALMA will supply rack-mounting hardware, such as captive nuts and screws, compatible with the rack.*

**Rack space requirements:** 44U, 19" rack mounted, 30" depth. (This space is divided amongst four independent recorder subsystems, each of which consists of two recorders (5U) and one cable try unit (1U)). Possibly additional rack space of approximately 7U may be required for the following equipment: a 1 Gbe network switch, a 10 Gbe network switch.

*If ALMA has any preference on network switches, they will provide manufacturers and part numbers and APP will purchase.*



**Interface Control Document Between ALMA  
Phasing Project And ALMA Site**

Doc #: ALMA-05.11.10.00-20.00.00.00-A-ICD  
Date: 2014-10-14  
Page: 26 of 26

***ALMA will supply rack-mounting hardware, such as captive nuts and screws, compatible with the rack.***

**Power requirement:** 6 KW, typical, distributed as 4 X 6A at 240 VAC. Interface points are four AC connectors in the rack-mounted power strips. The connector type is IEC320C13.

**Cooling:** Air intake from front of chassis; air exhaust from rear of chassis.